

IAC-22-E2,3-GTS.4,4,x71794

BUTCube – road for CubeSat in-orbit solar eclipse observation mission utilizing 1U demonstrator

Václav Lazar ^{a*}, Jaroslav Bartoněk ^a, Petr Malaník ^b, Štěpán Rydlo ^b, Tomáš Láznička ^c, Robert Popela ^a

^a *Institute of Aerospace Engineering, Brno University of Technology, Technická 2896/2, 616 69 Brno, Czech Republic, vaclav.lazar@vut.cz*

^b *Department of Intelligent Systems, Brno University of Technology, Bozotechova 2, 612 00 Brno, Czech Republic*

^c *Institute of Physical Engineering, Brno University of Technology, Technická 2896/2, 616 69 Brno, Czech Republic*

* Corresponding Author

Abstract

An In-orbit Solar Eclipse Observation mission was pre-selected for the potential future scientific flight mission of the Brno University of Technology (BUT, Czech Republic) CubeSat. The mission would be a valuable addition to existing top-level research of Sun Corona at BUT, performed in cooperation with University of Hawaii. The goal is to perform space-based Corona observation during Sun eclipse by Moon. This mission significantly expands the concurrent options by increasing number of possible observations of total Solar eclipses and providing the unique data from region close to the Sun's surface. The flight mission is to be simulated on 1U BUTCube platform, that is currently under development. BUTCube is the very first student CubeSat project at BUT. Composed of 5 Ph.D. candidates, pioneering in space technology, the team was supported within an internal Ph.D. grant competition. This paper presents the demonstration mission development and lessons learned. The flight mission requirements, including potential observation orbits were studied. An algorithm capable of searching the observation orbits and their parameters was proposed. This allows the further electric power, link and thermal budget scaling and creates a benchmark for the demonstration or flight mission. The 2025 observation orbit was further analysed. All the 1U BUTCube systems are custom-made, adopting ESA's Fly Your Satellite design specification. The EPS and communication systems were designed with respect to the planned mission. BUTCube frame will be 3D printed from PEEK material and subjected to experimental eigen frequency testing. The experiment should support modal analysis results, creating inputs for future structural considerations. The frame will also house 2 MPx camera simulating the main flight mission payload. The demonstration goal is to test the CubeSat system's functionality including image processing in the same way as they would be handled onboard flight mission. With no previous CubeSat knowledge, the team plans to embrace the CubeSat development experience during the flight mission preparation and upcoming BUT CubeSat projects.

Keywords: CubeSat, Solar eclipse, Solar Corona, Space mission

1. Introduction

Solar atmosphere studies have broadened our understanding of the various space weather phenomena such as Solar wind or Coronal Mass Ejection (CME) that are threatening humankind's technologies in space and on the ground. These phenomena originate in the Solar corona, observable in visible wavelength during the total solar eclipse or with coronagraphs. The white-light imagery allows visualization of the solar magnetic field and further spectroscopy analyses. For these dynamic events studies, the region spanning from the sun's surface above several solar radii outward is the most crucial. Yet, the low heliocentric altitudes remain blind to space-based coronagraphs due to light diffraction on the occulter [1]. With the combination of four coronagraphs, the LASCO on Solar and Heliospheric Observatory (SOHO) mission can observe regions from 1.1 to 30 R_{\odot} . [2] Alternatively, the closest limb regions can be observed during the total solar eclipse on the ground.

With a focus on periodical solar corona observation opportunities, multiple authors proposed

a celestial body occultation. Habbal proposed an explorer-type mission to the Lunar orbit. Such a configuration would result in periodical 20 minutes-long expositions of coronal sections over the lunar surface with observable solar altitudes of 3 R_{\odot} . [3] Utilizing Moon as an occulter was also patented by Eckersley and Kemble, providing a wide target zone with 1 – 1.02 R_{\odot} observation expositions. [4] Patent authors assume a non-Keplerian controlled orbit. Bernardini et. al. suggested Earth as a natural occulter in a small satellite mission for a periodical data collecting of the inner Sun corona down to 1.02 R_{\odot} . [5] In ESA's Proba-3 mission concept [6] the Sun's disc is occulted with a spacecraft flying in formation with a second spacecraft that will observe such an artificial eclipse. Both satellites are to be placed in a highly elliptical orbit, allowing 6 hours-long observations down to 1.08 R_{\odot} per orbit.

Space-based Solar corona observation was also proposed as a future BUTCube scientific mission. Unlike in the above-mentioned mission concepts, we suppose the observation to be performed with a small satellite located in Low Earth Orbit (LEO). The

Moon will be utilized as an occulter as depicted in Figure 1. In this way, the satellite will observe the Solar corona in a visible wavelength and close to the solar limb. Since the mission goals are achievable from LEO with a small standardized satellite, we find the mission to be simpler and much less expensive in comparison with other scenarios mentioned above. Despite this, the scientific potential is not reduced. The mission relies on existing technologies only. A 1U demonstrator CubeSat is currently being developed within the BUTCube project at the Brno University of Technology. The goal is to demonstrate the flight mission objectives fulfilment during on-ground testing, while adopting the CubeSat technology at the university.

In this paper, we present the current results of the ongoing CubeSat project. A potential flight mission and its orbit finder algorithm are described first. The flight mission demonstration goals and 1U CubeSats systems are reviewed in Section 3. 3D printed frame design and platform development are described in section 4. Lessons learned obtained during the project investigation are summarized in section 5.

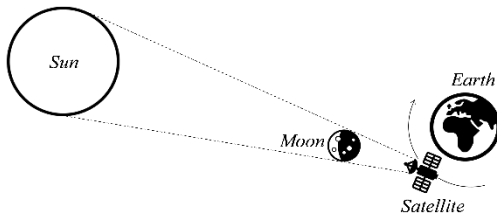

Fig. 1: BUTCube flight mission proposal for solar corona observation from LEO during artificial eclipse utilizing Moon.

2. BUTCube mission

The proposed BUTCube flight mission heavily depends on the orbit selection. For that purpose, the orbit-finding algorithm was created. The algorithm is based on the observation conditions (OC). The OCs combine the mission requirements that ensure orbit suitability for the mission:

- OC1: Minimum and maximum altitude
- OC2: Type of Eclipse
- OC3: Duration of Eclipse
- OC4: Assessment of orbit parameters

The OCs are applied as boundary conditions or determination criteria within the Keplerian orbit calculation steps as depicted in Figure 2 below. Generally, the algorithm of orbit calculation consists of three steps. The first of them returns the position of the satellite at the moment of entry into the Moon shadow, while the second one is iterative and calculates its total velocity vector so that the final orbit meets also the OC3 and OC4. Coordinates of Earth and Moon are taken from GMAT R2020a software. The rest can be done in a table processor.

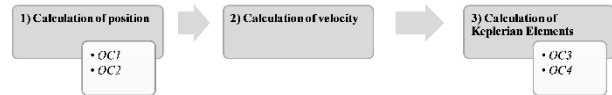

Fig. 2: Calculation steps in BUTCube mission orbit determination

The OCs may be set to output desired orbits. In the presented analysis, the OC1 – Minimum and maximum altitude was restricted for LEO with altitudes in the range 200 – 600 km. Only total solar eclipses were enabled in OC2. A minimum eclipse duration of the 30s is required in OC3 to enable a full ACHF method [7] post-processing of white-light images obtained with variable exposition times during corona observation. Calculated potential mission orbits are further sorted based on their accessibility. Sun-Synchronous, low eccentricity orbits and ISS inclinations are preferred.

A total of 24 suitable orbits complying with the above-mentioned OCs were found in the 2024-2030 epoch. The solar disc occultation in all cases is within the 1.02 – 1.07 range, promising great scientific potential. Two kinds of results may be recognized relative to on-ground total eclipse observations:

- Concurrent observation opportunity
- Unique observation opportunity.

Concurrent observation orbits found in 2024, 2026, 2027, 2028 and 2030 are an opportunity for the on-ground and in-orbit low altitudes solar corona images comparison and combination as it has been done before. [8] Multiple orbits were found during one on-ground event.

Unique observation orbits allow close Sun-surface corona documentation in the years 2025 and 2029, where no data are to be gathered from the on-ground observations. The 2025 observation opportunities are visualized in Figure 3. One can notice that unique opportunities are associated with the on-ground partial solar eclipse event – Figure 3 left. Benefiting from the higher altitude and variable inclination, three different observation orbits were calculated.

Unfortunately, no periodical observations were found within the presented orbits. Assuming a 6U CubeSat for the proposed flight mission, we suppose a secondary payload and mission to be integrated on the spacecraft as well. With corona observation opportunities found on nominal LEO, the secondary mission may include any experiment or demonstration typical for other CubeSats missions. No secondary mission was selected yet. Featured mission study does not replace a mission analysis as such and serves more as a feasibility study, since the flight mission is not an objective of the current BUTCube project.

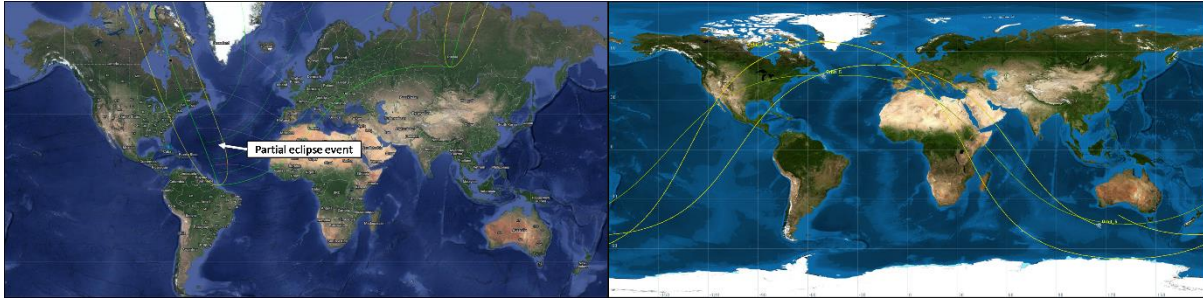

Fig. 3: March 29th 2025 Partial solar eclipse event map (left) and three observation orbits calculated via developed orbit finder algorithm (right). The orbits provide total solar eclipse event in duration from 1:05 – 2:04 minutes, covering 1.039 R_{\odot}

2.1. Mission sequence

It is evident that achieving of the corona observation orbit is going to be challenging even with the assumed integration of the propulsion and 3-axis stabilization systems. However, it is convenient to describe an ideal flight mission plan supposing a launch orbit to be close to the desired observation one.

Proposed mission phases:

- **Phase A: orbit achieving**
Spacecraft commissioning, orbit achieving and stabilization manoeuvres before the actual observation opportunity
- **Phase B: calibration**
Orbit maintenance and optical systems calibrations – dark frame calibration. Includes data collecting, transmitting to ground station and on-ground processing
- **Phase C: observation & operations**
Performing a white-light corona observation during artificial eclipse utilizing Moon as an occulter
- **Phase D: secondary mission & operations**
Secondary mission data collecting and operations on uncontrolled orbit after corona observation
- **Phase E: disposal**
Mission disposal according the available mechanisms on board of the flight spacecraft.

3. Flight mission demonstration

3.1. 1U demonstrator goals

The 1U BUTCube demonstration focused on the Phase B and Phase C of the proposed scientific mission. This mostly includes testing of the functionality of the camera, capturing the image and demonstration of the image data processing from the camera. The captured image is to be processed by the available electronics onboard and transferred wirelessly into the simulated ground station. The idea is to design a functional system and to enable the system modifications and scaling in the future. For the system development, we have adopted an ESA's Fly Your Satellite! – 3 Design Specification (ESA-FYS).

3.2. 1U demonstrator system overview

A system diagram of the demonstrator in the development is presented in Figure 4. The system is composed of Electrical Power System (EPS), Energy Harvesting System (EHS), Attitude Determination Control System (ADCS), Communication (COMMS), On-board Computer & Data Handling (OBC & ODH), and structure – mechanical. The systems are integrated within actual hardware modules as depicted in Figure 4.

The stack connector supports both regulated and unregulated power distribution. Supported communication protocols are SPI, I2C, CAN and RS-485. The stack connector also enables QSPI communication for large data such as images.

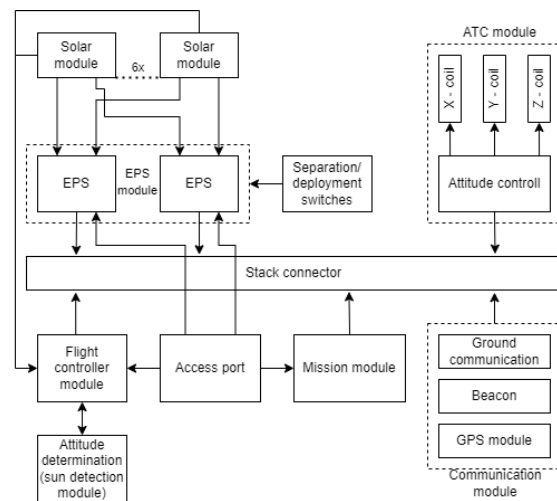

Fig. 4: 1U BUTCube demonstrator system diagram

Electrical Power System & Energy Harvesting System

1U BUTCube EPS & EHS consists of 6 solar panels with a total maximum power of 8 W, two 18650 batteries for energy storage and sensors for measuring batteries temperature and the amount of stored energy. EPS has an integrated battery heating system to provide required temperature comfort and life incensement of batteries. The power output of the designed EPS has a 3 regulated and monitored power rails for voltages: 1.8 V, 3.3 V, 5 V. Capacity of the battery system is 35.28 Wh.

Attitude Determination Control System

It was determined that during the observation it would be necessary to maintain stability in values between one and two angular minutes within 30 seconds. Precise pointing and 3-axis stabilization will be required for the flight mission. Demonstrator will include three magnetotorques and solar sensors on the outer sides of the BUTCube instead.

Communication System

Communication consists of beacon, telemetry and data transfer subsystems. A beacon telemetry information is transmitted through OpenLST radio. Ground communication part is for the image data transfer through nRF, simulating the S-band communication on flight satellite. Position of microsatellite is determined via integrated GPS module. Communication system has its own microcontroller processing and receiving the signals from ground, or stack connector.

On-board Computer & Data Handling System

Two computers are integrated within the demonstrator system – the flight computer and the mission computer. While the flight computer should secure the CubeSat orientation and stabilization, the mission computer controls (I2C protocol) the optical payload of the demonstrator – 2 MPx camera. Both computers are connected to a stack connector. The Mission computer on the mission module also distributes image data through the QSPI protocol.

Mechanical System

The concept of the mechanical design of the CubeSat was chosen as a challenging mission in the form of a fully printable frame. In this regard, the final model will be manufactured utilizing a 3D print. This task also involves material outgassing research. The mechanical limits are to be further reviewed with the modal analysis. All requirements for the construction of the CubeSat and its mechanical properties are based on the ESA-FYS design specification.

4. BUTCube mechanical design

As part of the BUTCube project for the creation of a 1U demonstrator, three concepts of the basic structure (frame) of the CubeSat were created. In the first two concepts, consideration was given to the simplicity and easy manufacturability of the frame with a small number of joints and parts. These two concepts were then analysed and compared. The result of this analysis was the creation of a third, final concept, which was optimized for the FDM (Fused deposition modelling) 3D print manufactured process.

The FDM 3D printing method was considered for the production process of the BUTCube frame. This provides a unique opportunity for CubeSat

production in orbit. The 3D printing method is also very advantageous in utilizing a fast prototyping approach that enabled the handling testing that leads to multiple part optimization. It can also occur with relatively good production accuracy. PEEK or PEI material is considered for the CubeSat. Fully printed (FDM) versions including frame and rail parts are currently being preferred for the demonstrator. Unfortunately, this approach is not in accordance with the ESA-FYS Design Specification material requirements. However, the decision was made due to the scientific and research focus of the project.

No 3D printed PEEK/PEI outgassing data was found, only raw, non-printable materials and their properties. We assumed that the ratio between the properties of individual materials would be similar for printable materials. Due to the lack of data from 3D printed materials, the estimation of the outgassing of the printed material should be determined experimentally. From the tables for non-printable materials, it can be concluded that PEI suffers from higher Total Mass Loss (TML) values [9][10]. Better degassing properties can be achieved by post-production processing. Baking is generally preferred. However, this may not be available for polymeric materials. From the commercially available materials on the market, only PEEK 450G903 complies with both outgassing requirements.

The assembled frame weighs a total of 164 g, which is currently at the level of frames that are made using conventional methods from aluminium alloys. In this respect, however, there is a lot of space for improvement and optimization of parts and thus also weight reduction while maintaining the same mechanical properties of the frame.

4.1. BUTCube frame concepts

The first concept was designed to minimize the number of parts to be printed. The concept consisted of two parts. The primary part contained the five faces of the frame, which were printed in one piece. The last side of the frame was connected to the rest of the structure using screws and countersunk nuts in the frame of the CubeSat. However, it was found that the print orientation of the bigger part was not ideal due to perpendicular print directions. This resulted into the mechanical loads into weaker joints of print layers. In this way, the structure stiffness was not optimal for all sides of the CubeSat. [11]

The second concept was created for the easier access and handling of the internal electronics assembly. The frame consisted of two parts that are joined together by a hinge in one of the frame rails. The structure of the frame faces were almost identical to the previous version. The hinge was located inside the Rotation rail and rested with the rail cap. This concept also did not allow the optimal print direction for the CubeSat faces. Moreover, the

inner space of this CubeSat concept was not significantly larger than the previous one.

Subsequently, an analysis of both concepts and a comparison of their parameters were carried out. Among these parameters, their weight, the maximum area of all internal PCBs for electronics, access to the important parts of the CubeSat assembly, stiffness of the frame, and the number of parts (= complexity of composition and inaccuracies) stood out the most. Further research and experience from the previous designs gave rise to the third design concept, where the structure and mechanical properties of the used 3D printing technology were taken into account.

4.2. Final frame design

The main structure of the third frame concept is composed of six parts, which are attached to each other with screw and shape connections. The reason for distributed design is the orientation of the print. All parts of the frame are printed on the side towards the pad and the printing itself is performed on the +Z axis. In this direction, parts are stronger than parts printing in the standing state (as was the case in some faces in previous concepts).

In the middle of the side frames, there are central holes that house the Access port on +X side and the camera on -Y side. The rest of the central holes are equipped with the Sun Sensor modules for the CubeSat orientation determination. The solar panels are designed around the central holes and attached through the shared screw connections.

4.3. Modal analysis of the third frame concept

The reason for the modal analysis is to support the frame design concept choice, to create a benchmark for any future design considerations and to check the specification fulfillment stating the CubeSat minimum natural frequency of 100 Hz. The goal is to find the limit weight that ensures the eigenfrequency of the frame itself to be above the required level. The natural frequencies are calculated by using NASTRAN 2019 finite element method.

The weight of all internal equipment is represented by concentrated mass element (CONM2) located at the geometric centre of the CubeSat (which does not necessarily coincide with CoG, but remains in acceptable tolerance). The frame is the only part modelled in detail. It consists of parabolic tetrahedral elements (CTETRA). All screws are replaced by linear 1D beam elements (CBEAM) with the appropriate diameter. These are connected to adjacent structure by rigid elements RBE3. Also, the mass element is connected by RBE3 to beam elements to represent the mass of internal printed circuit boards.

Natural frequencies are affected by the stiffness and mass of the structure. The stiffness is related to the material used. Thus, there were two materials of the CubeSat frame considered. The first one counts with 3D printed PEEK frame while the second one

uses standard aluminium frame. Both versions use linear isotropic material model MAT1. In case of PEEK material, this is a simplification due to commonly known anisotropic properties of 3D printed parts. However, the anisotropy is related mainly to strength in different directions. This parameter is not so important for the natural frequency calculation; thus, we suppose this simplification as acceptable. All analyses have proved that the first natural frequency manifests on the internal weight, not on the frame.

Tab. 1. Overview of the CoG mass limit for modal analysis of PEEK and Al Concept 3 frame design

Mass / concept	Concept 3 - PEEK	Concept 3 - Al
Frame & connections [g]	187	372
CoG mass limit [g]	1,143	958

For each of the versions described above, 10 finite element models were prepared with different weights of the central mass element. The CoG element mass limit was determined based on the 1U CubeSat mass limit stated in the specification (1330g). The actual frame & connections mass of the proposed Concepts were calculated to get the theoretical “payload” limit after subtracting from the specification budget as presented in Table 1.

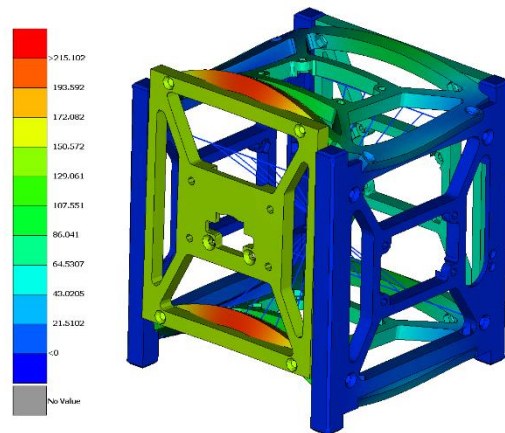

Fig. 5: 3rd eigenfrequency mode shape on 318,6 Hz of the Concept 3 PEEK with 571 g mass in CoG.

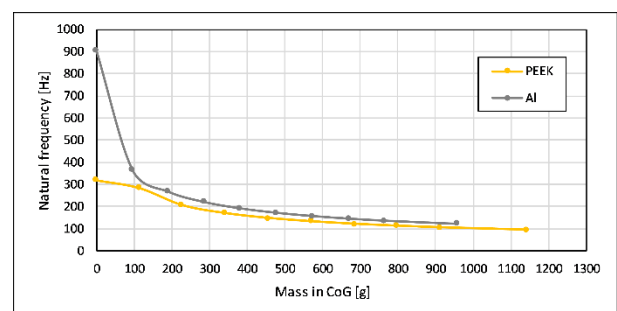

Fig. 6: Spectrum of natural frequencies results for Concept 3 PEEK and Concept 3 Al frame design with variable mass in CoG.

The solver used is MSC NASTRAN 2019.0, SOL 103 (SEMODES). The solution was made by Lanczos method. Only the first natural frequency and displacements of all nodes have been requested as output. The analysis helps to decide the limits of the proposed PEEK structure, relative to the Al version. It was found the mass of the internal payload of the PEEK structure should be kept below 800g to ensure the eigen frequency is above the requested level. Figure 5 depicts an analysis graphical output of the PEEK frame with 571 g in CoG. The overall results are summarized in Figure 6.

Future analyses will follow after the CubeSat design will be finished and all components weight will be known. These analyses will include much more detailed internal structure with PCBs, standalone masses, solar panels etc.

5. Lessons learned

Although only five Ph.D. candidates are involved in BUTCube project, the teamwork experience is one of the most valuable of all. With no previous experience with space projects, the team made a great deal by adopting the CubeSats technology and proposing a flight mission in a scientific field outside of team members' expertise. Working in a small team is instructive. With different fields of expertise to cover (hardware, mechanical, mission), the team is further divided into 3 sub-groups capable of working separately. Each team member is then involved in at least two individual groups. This hybrid structure allows working on parallel tasks as well as keeping an overview of shared actions. Scheduled weekly meetings are usually in an online environment since the team is composed of inter-faculties members with limited working time reserved for the project.

One of the experiences we gained during development was working with specifications. The demonstrator is designed according to the European Space Agency's "Fly Your Satellite" specification. The specification compiles multiple requirements from other standards as well but covers only the CubeSat sizes from 1U to 3U. With the particular modules being built from the scratch, the requirements adaptation was a great experience, especially for the hardware team. Considering the potential flight mission, we suppose an adaptation of the "CubeSat design specification" (California Polytechnic University in San Luis Obispo), which also includes criteria for 6U spacecraft, that is considered for the flight mission.

FDM 3D printing method is widely used in research and development as a quick verification of the functionality of designed components. During the development of some components, no emphasis is placed in the initial phase on its mechanical properties, which recede into the background. During fast prototyping, common materials are mostly used, which are affordable and less

demanding to print than materials, which are more expensive or their printing is more difficult. The 3D printed breadboards lead to multiple parts modifications that were not evident during design phase.

As part of the 1U demonstration mission, CubeSat systems and subsystems are to be tested. We designed demonstrator systems (Figure 4) to allow scaling for the actual flight mission. However, most of the modules, interfaces and interconnections may preserve as presented. The main focus of the 1U demonstration will be the image processing and handling with 2 MPx camera simulating the flight mission payload. The demonstrator is designed to allow integration and testing of the flight payload once obtained.

Dealing with market shortage of microcontroller units and other components, we decided to integrate the mission module within the communication module. In this way, we utilize the communication's MCU to handle the camera data. Therefore, the data can not be saved and are transmitted immediately. See Figure 7 for a communication module overview. This solution represents one of many compromises and learning experiences we had to undertake in order to preserve the demonstration capabilities.

Such an experience may also broaden on purchases and orders management. Considering custom assemblies, the inquiries and manufacturers should be planned ahead to avoid any market shortage or delivery delays. In general, building custom modules saves project funds and is a good solution for demonstration purposes and starting or learning projects such as BUTCube. However, such an approach is more time-consuming and involves more risks than purchasing off-shelf CubeSats solutions.

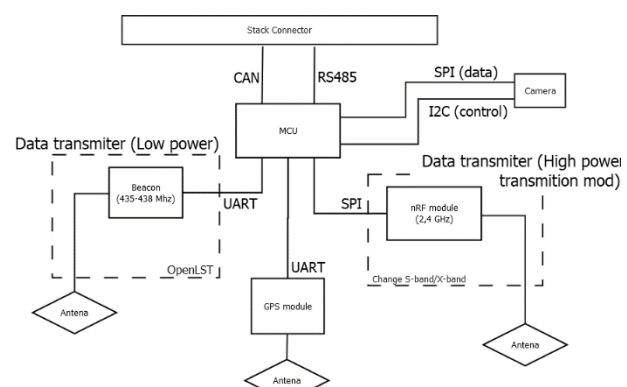

Fig. 7: Communication module with integrated camera simulating flight mission payload. In flight configuration, the camera is to be integrated within Mission module (Fig. 4) and data are to be transferred via stack connector to communication's data transmitter. The current solution does not provide a data storage that will be required for the flight mission.

6. Conclusions

The presented work highlights the progress done over the last year within the first student's CubeSat project at the Brno University of Technology. A unique scientific mission for small satellite was proposed. Suitable LEO for the Sun's corona white-light observation was found thanks to the developed algorithm. The potential flight mission is to be demonstrated on 1U CubeSat platform, currently in manufacture. Featured lessons learned, established supply chain, teamwork and system engineering approach are to be recognized within the future CubeSat projects.

Acknowledgements

The team of authors would like to thank prof. Miloslav Druckmüller for the tight cooperation and contribution during the mission feasibility study. The team of authors was supported by Quality internal grants project No. FSI-K-21-6996 at Brno University of Technology, Institute of Aerospace Engineering, realized within an OP VVV program reg. No.: CZ.02.2.69/0.0/0.0/19_073/0016948.

References

- [1] M. Druckmüller, S.R. Habbal, H. Morgan, Discovery of a new class of coronal structures in white light eclipse images, *Astrophysical Journal*. 785 (2014). <https://doi.org/10.1088/0004-637X/785/1/14>.
- [2] Brueckner, G. E., Howard, R. A., Koomen, M. J., Korendyke, C. M., Michels, D. J., Moses, J. D., Socker, D. G., Dere, K. P., Lamy, P. L., Llebaria, A., Bout, M. v., Schwenn, R., Simnett, G. M., Bedford, D. K., & Eyles, C. J. (1995). The Large Angle Spectroscopic Coronagraph (LASCO). *Solar Physics*, 162(1–2), 357–402. <https://doi.org/10.1007/BF00733434>
- [3] S.R. Habbal, H. Morgan, M. Druckmüller, A. Ding, J.F. Cooper, A. Daw, E.C. Sittler, Probing the Fundamental Physics of the Solar Corona with Lunar Solar Occultation Observations, *Solar Physics*. 285 (2013) 9–24. <https://doi.org/10.1007/s11207-012-0115-5>.
- [4] S. Eckersley, S. Kemble, Method of solar occultation, EP 2 641 833 B1, 2017. <https://patents.google.com/patent/EP2641833B1/en> (accessed July 27, 2022).
- [5] N. Bernardini, N. Baresi, R. Armellini, S. Eckersley, S.A. Matthews, Trajectory design of Earth-enabled Sun occultation missions, *Acta Astronautica*. 195 (2022) 251–264. <https://doi.org/10.1016/j.actaastro.2022.02.027>.
- [6] J.S. Llorente, A. Agenjo, C. Carrascosa, C. de Negueruela, A. Mestreau-Garreau, A. Cropp, A. Santovincenzo, PROBA-3: Precise formation flying demonstration mission, *Acta Astronautica*. 82 (2013) 38–46. <https://doi.org/10.1016/J.ACTAASTRO.2012.05.029>.
- [7] M. Druckmüller, V. Rušin, M. Minarovjech, A new numerical method of total solar eclipse photography processing, 2006.
- [8] M. Druckmüller, S.R. Habbal, N. Alzate, C. Emmanouilidis, Tethered Prominence-CME Systems Captured during the 2012 November 13 and 2013 November 3 Total Solar Eclipses, *The Astrophysical Journal*. 851 (2017) L41. <https://doi.org/10.3847/2041-8213/aa9ed5>.
- [9] ESA Publications Division: SPACEMATDB, <https://www.spacematdb.com/spacemat/>, (accessed 01.09.22).
- [10] NASA Goddard Space Flight Center: Outgassing, <https://outgassing.nasa.gov/index.php/outgassing-data-table>, (accessed 01.09.22).
- [11] ARIF, M.F., S. KUMAR, K.M. VARADARAJAN a W.J. CANTWELL, 2018. Performance of biocompatible PEEK processed by fused deposition additive manufacturing. 146, 249-259. ISSN 02641275. Available: doi:10.1016/j.matdes.2018.03.015